

Valentin

SITS



Valentin

UPHOLSTERY



COMFORTS



COVERS

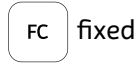

Armchair and footstool available only in standard comfort.

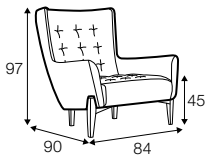

armchair

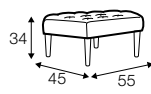

footstool 55x45

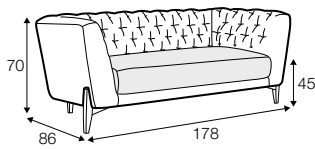

2 seater

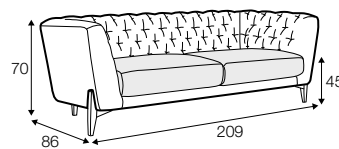

3 seater

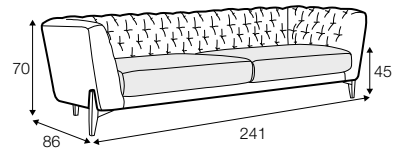

4 seater

extra dimensions

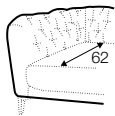

depth of seat

accessories

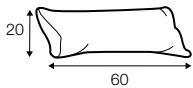

low back cushion
60x20
2 seater

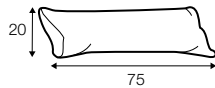

low back cushion
75x20
3 seater

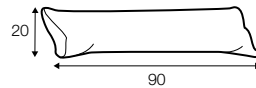

low back cushion
90x20
4 seater

legs

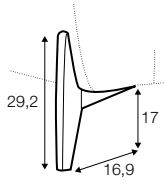

no. 193
wood

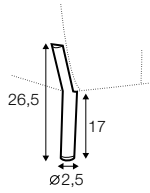

no. 194
metal chrome,
painted black or grey,
brass gold
and brushed steel

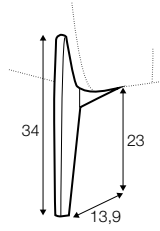

no. 193A
wood
front: only for
armchair

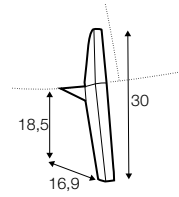

no. 193B
wood
back: only for
armchair

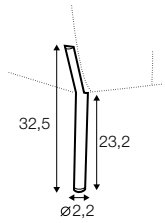

no. 194A
metal chrome,
painted black or grey,
brass gold
and brushed steel
front: only for
armchair

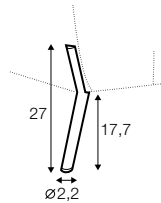

no. 194B
metal chrome,
painted black or grey,
brass gold
and brushed steel
back: only for
armchair

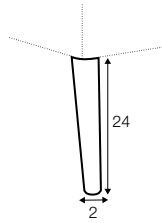

no. 197
wood
only for footstool

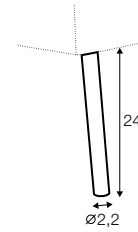

no. 160A
metal chrome,
painted black or grey,
brass gold
and brushed steel
only for footstool

profile

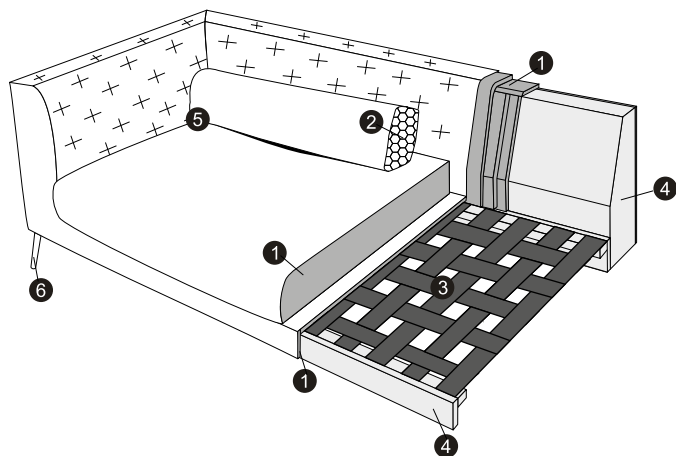

standard

1. polyurethane foam / high resilient polyurethane foam
2. silicone balls
3. upholstery belts
4. FSC® certified solid wood and wood based elements
5. fabric
6. FSC® certified solid wood or metal legs

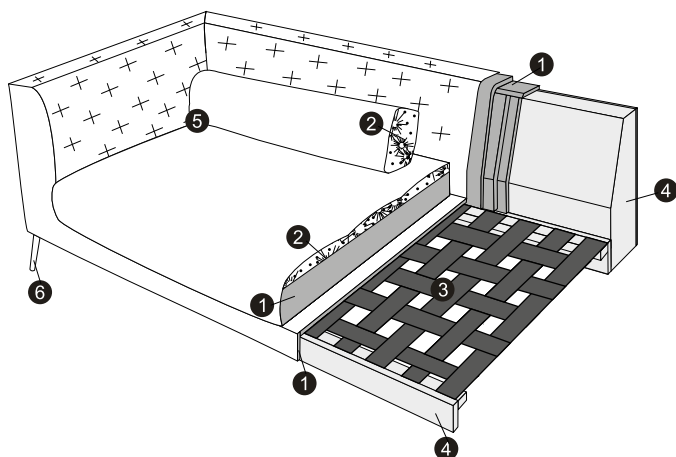

lux

1. polyurethane foam / high resilient polyurethane foam
2. cushion chamber with mix of feather and silicone balls
3. upholstery belts
4. FSC® certified solid wood and wood based elements
5. fabric
6. FSC® certified solid wood or metal legs