

# Felix

# SITS



# Felix

UPHOLSTERY

COMFORTS

COVERS



Drawings shown height with leg no. 111D

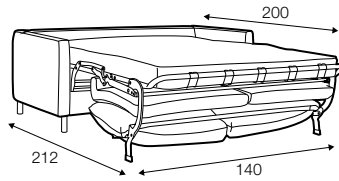
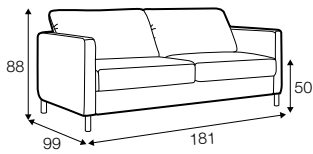

3 seater sofa bed

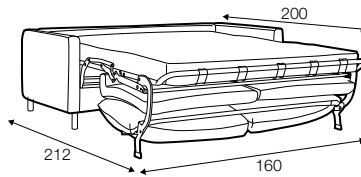
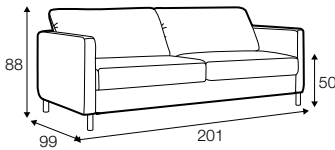

4 seater sofa bed

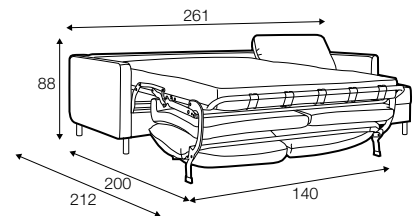
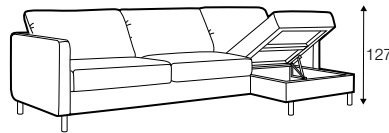
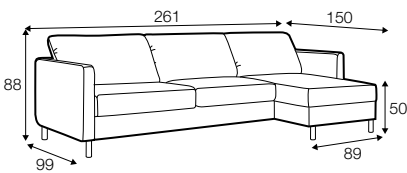

set 1 right / or left

3 seater sofa bed left / or right + chaiselongue box right / or left

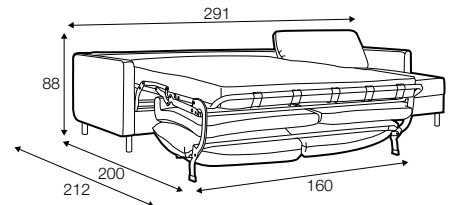
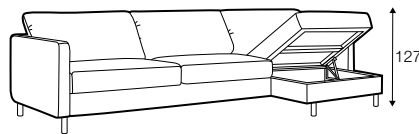
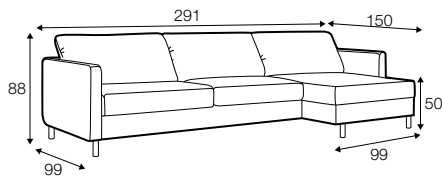

set 2 right / or left

4 seater sofa bed left / or right + chaiselongue box right / or left

## extra dimensions

---

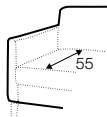

depth of seat

## legs

---

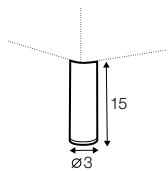

no. 111D  
metal chrome,  
painted black or grey  
and brushed steel\*

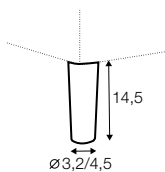

no. 153  
wood

\*please check a cost of brushed steel finish with a sale representative.

## profile

---

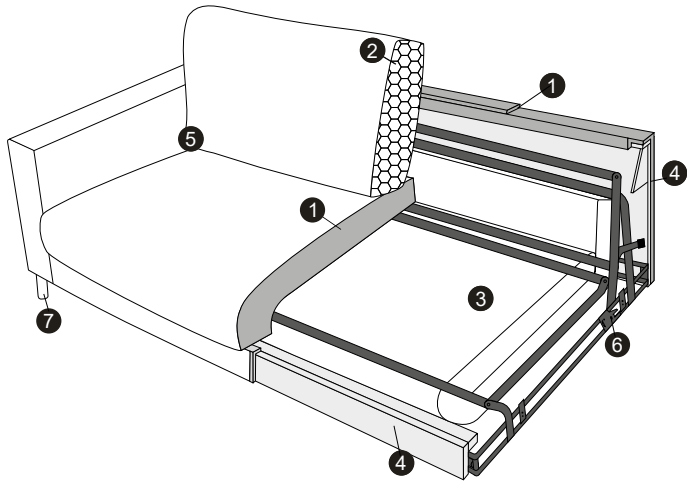

### standard

1. polyurethane foam / high resilient polyurethane foam
2. silicone balls
3. bonell or foam mattress
4. FSC® certified solid wood and wood based elements
5. fabric
6. metal mechanism
7. solid wood / metal legs