

QUATTRO

All drawings shown with standard armrest 400.
Seat height given is with feet no 53 H-100.

www.sits.eu
JULY 2018

ARMCHAIR 71

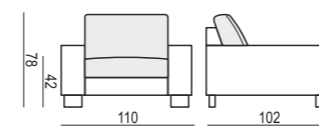

ARMCHAIR 71 LEFT (or RIGHT)

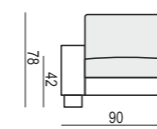

ARMCHAIR 71 without ARMRESTS

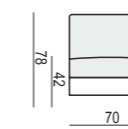

2 SEATER 71

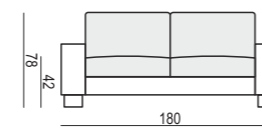

2 SEATER 71 LEFT (or RIGHT)

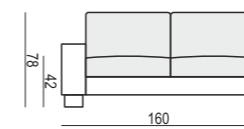

2 SEATER 71 without ARMRESTS

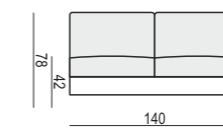

3 SEATER XL 71

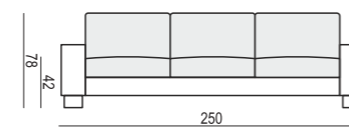

3 SEATER XL 71 LEFT (or RIGHT)

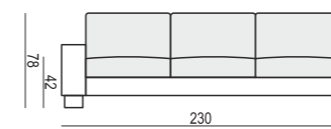

3 SEATER XL 71 without ARMRESTS

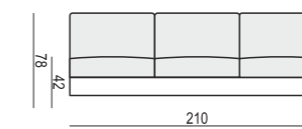

CHAISELONGUE 71 LEFT (or RIGHT)

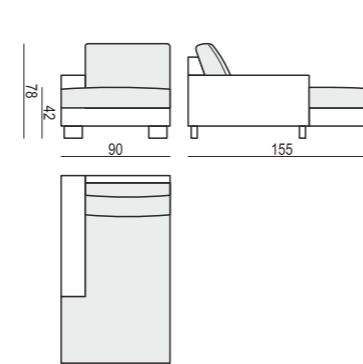

BENCH 71 LEFT (or RIGHT)

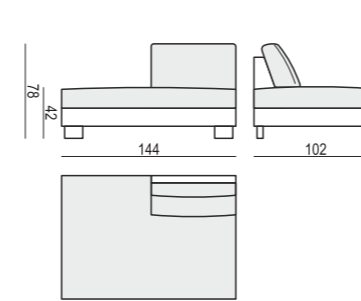

FOOTSTOOL 70x53
version 91x71

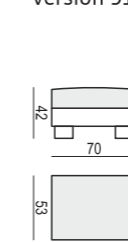

3 SEATER 91

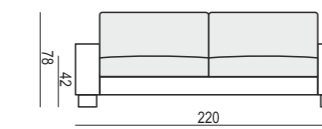

3 SEATER 91 LEFT (or RIGHT)

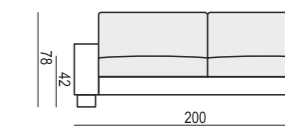

3 SEATER 91 without ARMRESTS

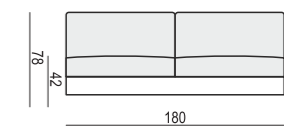

CHAISELONGUE 91 LEFT (or RIGHT)

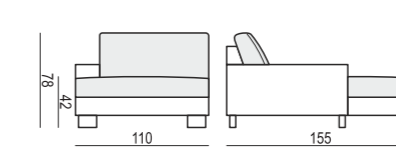

CHAISELONGUE 91 LONG LEFT (or RIGHT)

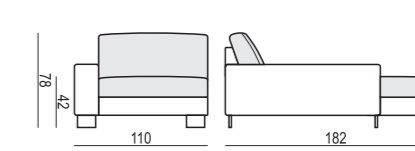

BENCH 91 LEFT (or RIGHT)

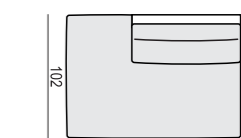
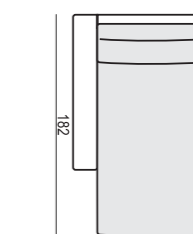
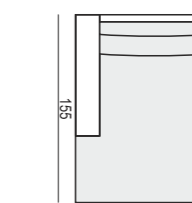
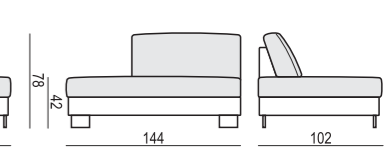

FOOTSTOOL 90x53
version 91x71

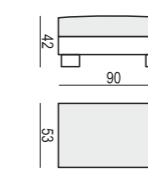

FOOTSTOOL 90x90
version 91x71

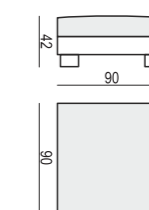

HEADREST L-80 Ø16

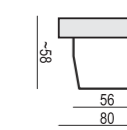

HEADREST L-80

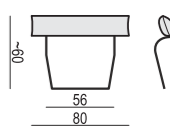

SOFA BED

Standard comfort – only version 70 for fabric and leather

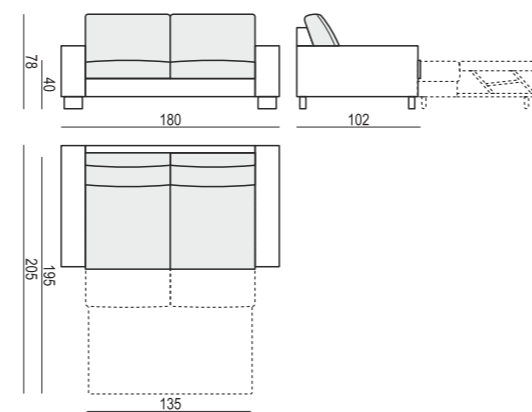

HEADREST L-60 Ø16

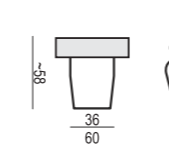

HEADREST L-60

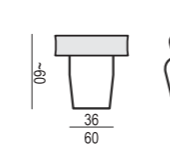

CORNER 90° No. 310

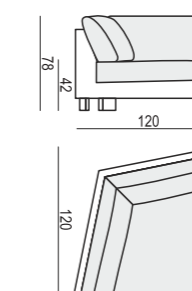

CORNER 90° No. 320

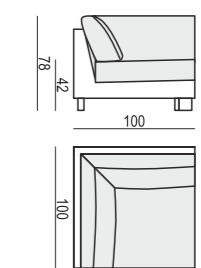

ARMREST 400
100 x 20 x 42 cm

available with feet:
no. 47, no. 51, no. 53,
no. 61A, no. 145A, no. 176
legs to SB H-100:
all above

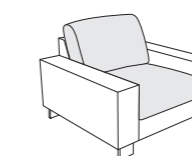

ARMREST 450
100 x 12 x 47 cm

available with feet:
no. 47, no. 51, no. 53,
no. 61A, no. 145B, no. 176
legs to SB H-100:
no. 145B, no. 176

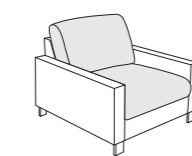

ARMREST 460
100 x 27 x 47 cm

available with feet:
no. 47, no. 51, no. 53,
no. 61, no. 145A, no. 176
legs to SB H-100:
all above

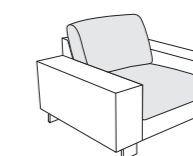

ARMREST 480
101 x 17 x 56 cm

available with feet:
no. 47, no. 51, no. 53,
no. 145B, no. 176 L-60
legs to SB H-100:
no. 145B, no. 176 L-60

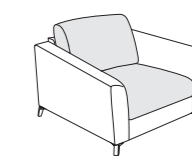

ENDPART LEFT
(or RIGHT)
98 x 55 x 2,5 cm

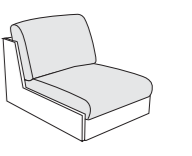

ARMCHAIR 91

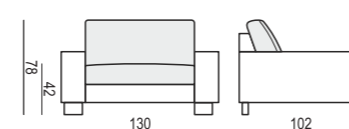

ARMCHAIR 91 LEFT (or RIGHT)

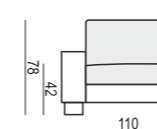

ARMCHAIR 91 without ARMRESTS

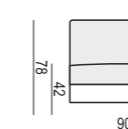

QUATTRO

www.sits.eu
JULY 2018

SET 1 LEFT (or RIGHT) CHAISELONGUE 71 LEFT (or RIGHT) + 2 SEATER 71 RIGHT (or LEFT)

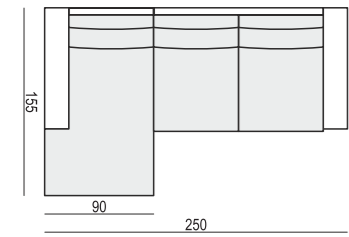

SET 2 LEFT (or RIGHT) CHAISELONGUE 91 LEFT (or RIGHT) + 3 SEATER 91 RIGHT (or LEFT)

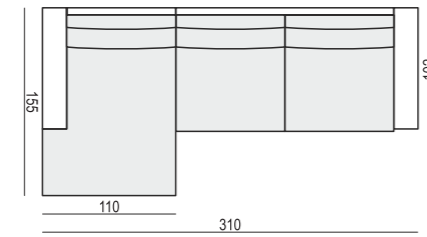

SET 14 LEFT (or RIGHT) BENCH 71 LEFT (or RIGHT) + CORNER 90° No.320 + 3 SEATER 91 RIGHT (or LEFT)

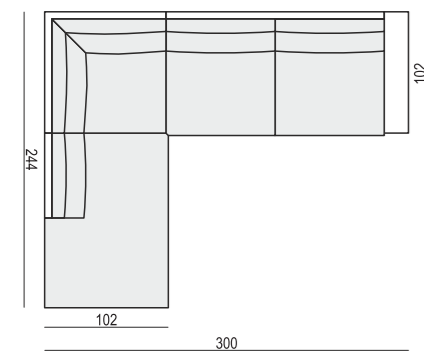

SET 16 LEFT (or RIGHT) CHAISELONGUE 91 LONG LEFT (or RIGHT) + 3 SEATER 91 RIGHT (or LEFT)

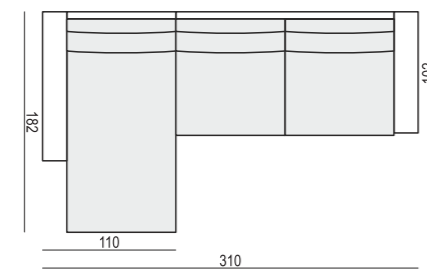

All drawings shown with standard armrest 400.

UPHOLSTERY

FABRIC and LEATHER: FC - fix cover

FEET

No. 47 metal chrome, painted black or grey and brushed steel*

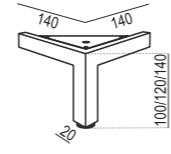

No. 47A metal chrome, painted black or grey and brushed steel* (only to corners)

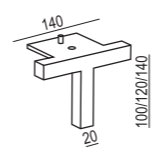

No. 51 wood

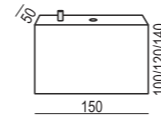

No. 53 metal chrome, painted black or grey and brushed steel*

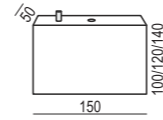

No. 61 metal chrome, painted black or grey and brushed steel*

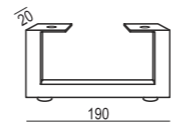

No. 61A metal chrome, painted black or grey and brushed steel*

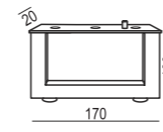

No. 145A metal chrome, painted black or grey and brushed steel*

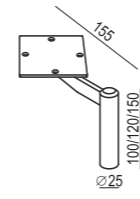

No. 145B metal chrome, painted black or grey and brushed steel*

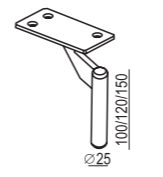

No. 176 wood

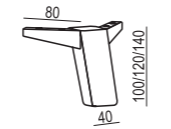

*please check a cost of brushed steel finish with a sale representative

SITS reserves the right to change construction of products and components used due to improving durability of product and customer satisfaction without any further notice. Explicit ±2 cm tolerance of all elements sizes. Drawings show the high for standard comfort seats. Lux comfort seats are 3 cm higher.

CLASSIC COMFORT

1. polyurethane foam/high resilient polyurethane foam
2. springs
3. solid wood and wood based elements
4. fabric or leather
5. solid wood or metal legs

STANDARD COMFORT

1. polyurethane foam/high resilient polyurethane foam
2. springs
3. solid wood and wood based elements
4. fabric or leather
5. solid wood/metal legs

LUX COMFORT

1. polyurethane foam/high resilient polyurethane foam
2. cushion chamber with mix of feather and silicone balls
3. springs
4. solid wood and wood based elements
5. fabric or leather
6. solid wood/metal legs

