

ARMCHAIR

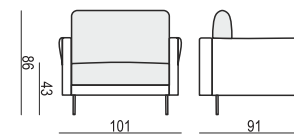

2 SEATER

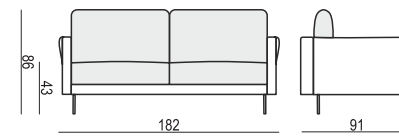

3 SEATER

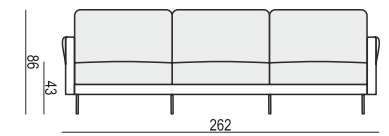

SEAT ELEMENT 80

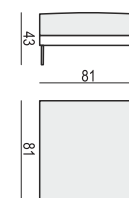

SEAT ELEMENT 160

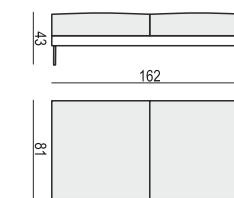

SEAT ELEMENT 240

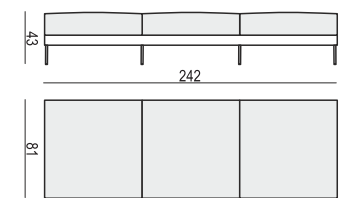

FOOTSTOOL

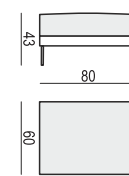

CUSHION 81x48



CUSHION 67x48

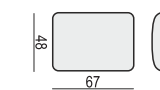

ARMREST / BACKREST available in loose cover

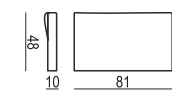

UNLIMITED POSSIBILITIES OF COMBINATIONS – BELOW EXAMPLE ARRANGEMENTS

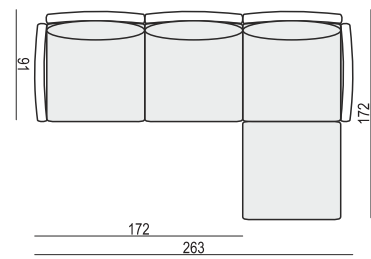
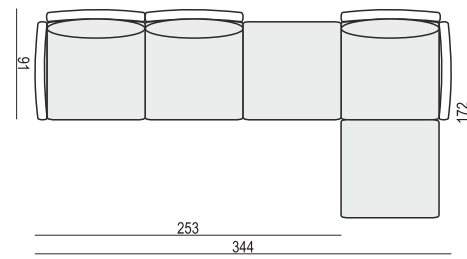
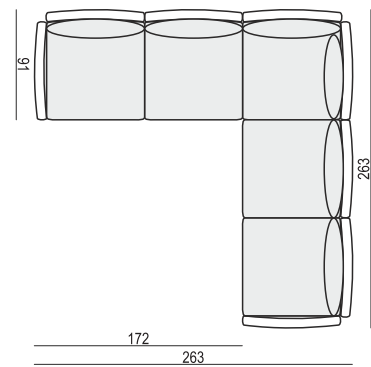
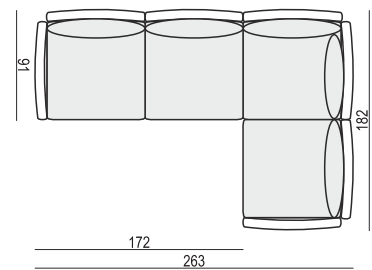
2x SEAT ELEMENT 160
+ 5x ARMREST + 3x CUSHION 812x SEAT ELEMENT 160 + SEAT ELEMENT 80
+ 5x ARMREST + 3x CUSHION 812x SEAT ELEMENT 160 + SEAT ELEMENT 80
+ 8x ARMREST + 5x CUSHION 81 + CUSHION 67SEAT ELEMENT 160 + 2x SEAT ELEMENT 80
+ 7x ARMREST + 4x CUSHION 81 + CUSHION 67

SITS reserves the right to change construction of products and components used due to improving durability of product and customer satisfaction without any further notice. Explicit ±2 cm tolerance of all elements sizes.

UPHOLSTERY

FABRIC: FC - fix cover

FEET

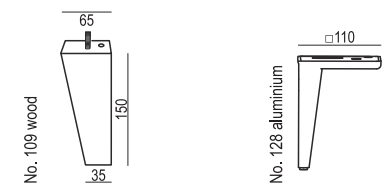

CLASSIC COMFORT

1. polyurethane and laminated foam
2. foam flakes with silicone balls
3. upholstery belts
4. FSC® certified solid wood and wood based elements
5. fabric
6. FSC® certified solid wood or metal legs

STANDARD COMFORT

1. polyurethane and laminated foam
2. foam flakes with silicone balls
3. bonnell springs
4. upholstery belts
5. FSC® certified solid wood and wood based elements
6. fabric
7. FSC® certified solid wood or metal legs

