



Fabrication Française



HOME SPIRIT

FRANCE

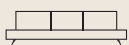

50 ANS

d'Expérience & et de Création en FRANCE

Fort de son expertise depuis plus de 50 ans grâce à son usine Mousse du Nord, Home Spirit conçoit votre canapé dans la tradition tout en restant à l'écoute permanente des attentes actuelles de ses clients ! Une équipe d'une centaine de personnes est experte dans tous les domaines de conception et de réalisation de votre canapé . Chez Home Spirit, la création et l'innovation sont essentielles. Le groupe possède son propre bureau d'études, composé d'experts et fait appel à des stylistes qui imaginent les produits de demain... et inventent ceux d'aujourd'hui.

Un état d'esprit qui repose sur une idée simple : chaque client Home Spirit doit trouver le mobilier qui lui ressemble.

IMPLANTATION DANS LE NORD DE LA FRANCE À NEUVILLE EN FERRAIN

Le groupe a fait le choix d'une implantation et une fabrication locale de très haute qualité. La maîtrise de l'ensemble du processus de fabrication est un point essentiel. Cette indépendance permet un contrôle et une réactivité absolue, conforme au niveau d'exigence de nos produits.

Exemple : 80% des achats de matières premières sont réalisés a moins de 100 kms de l'usine.

ENGAGÉ POUR L'ENVIRONNEMENT

Depuis sa création, Home spirit poursuit une démarche de développement durable renforcée par le Grenelle de l'environnement. Grâce à cette démarche, Mousse du nord a été récompensée en obtenant le certificat NF environnement.



17 Rue des Forts
59960 Neuville-en-Ferrain FRANCE
contact@homespirit.fr
tél. : + 33 (0)3 28 33 07 28





50 YEARS

of experience & creation in France



Capitalising on more than 50 years of experience thanks to its local factory Mousse du Nord, Home Spirit creates your sofa in keeping with tradition while staying tuned to the customers' latest expectations! Our team is composed of about one hundred people, all qualified in the various areas of the design and the manufacturing of your sofa. At Home Spirit, creation and innovation are essential. The Group has its own design office, staffed by experts and cooperating with stylists who imagine the products of the future... and invent the products of today This state of mind is based on a simple idea: every Home Spirit customer must find furniture to suit his or her taste.

LOCAL PRODUCTION
IN THE NORTH OF FRANCE
Top-quality local manufacture...
The Group has chosen the exclusive use of local manufacturing site in France, to control its entire product manufacturing process.
This independence provides perfect control and responsiveness, in keeping with the exacting standards of the company... and its customers.

Example: 80% of the raw materials are made less than 100 km from the factory.

IS COMMITTED TO THE ENVIRONMENT

Since its creation, Home Spirit has applied a sustainable development approach reinforced by the Grenelle Environment Round Table Thanks to this initiative, mousse du Nord was awarded the NF Environment certificate



17 Rue des Forts
59960 Neuville-en-Ferrain FRANCE
contact@homespirit.fr
tél. : + 33 (0)3 28 33 07 28





Fabrication Française

ABERDEEN

Contemporain & Épuré



HOME SPIRIT

FRANCE

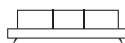

ABERDEEN

Contemporain & Épuré



Fabrication Française

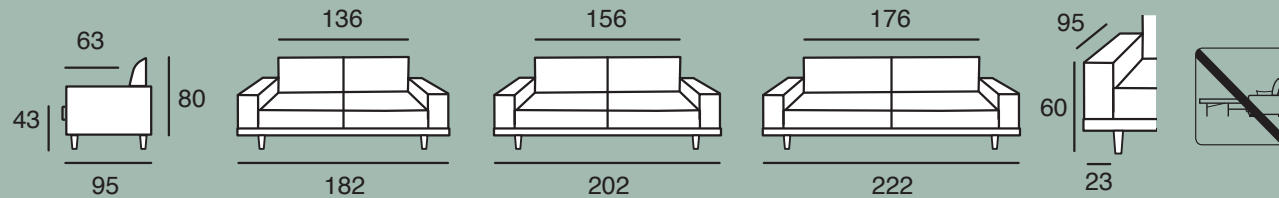

Structure : Hêtre, panneaux multiplex et panneaux de fibres. Structure enrobée de mousse polyuréthane et de ouate 650g, suspension sangles. **Assise** : Mousse HR 35 kg/m³ + percale remplissage plumes. **Coussins de dos** : Remplissage fibres siliconées. **Pieds** : Bois naturel. **Finition** : Tapissier.

Frame: Beech wood, multiplex and fiber panels. Frame wrapped in foam cover and double layered with a fiber cover. Suspension elastic bands. **Seat cushions**: Plumtex HR foam 35kg/m³ + layer of feathers. **Back cushions**: feathers & foam flakes. **Solid wooden legs**. **Fixed covers**.

HOME SPIRIT



homespirit.fr



Fabrication Française



ALBI

Aisance & Volume



HOME SPIRIT

FRANCE



ALBI

Aisance & Volume



Fabrication Française

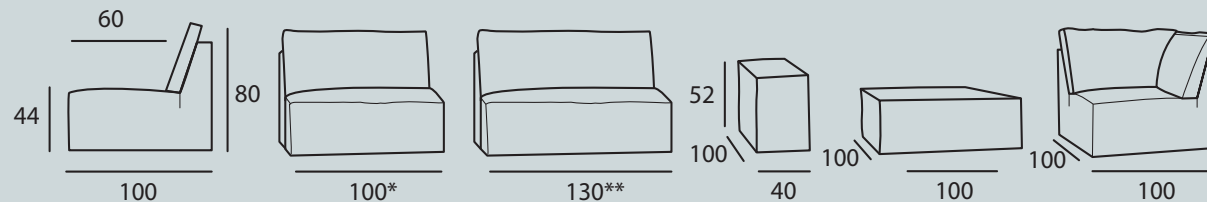

Option : largeur sur mesure : * de 70 à 100. ** De 100 à 130

Custom made elements : * from 70 to 100. ** from 100 to 130.

Structure : Hêtre et panneaux multiplex et panneaux de fibres. Structure enrobée de mousse polyuréthane. Manchette enrobée de ouate 650g. Suspension ressorts Nosags. **Assise :** HR 35 kg/m³ + HR 25 kg/m³ + ouate.

Coussins de dos : remplissage plumes/ flocons. **Finition :** tapissier, non convertible.

Frame : Solid beech wood, multiplex panels and fiber panels . Frame wrapped in foam cover and double layed with a fiber cover.Suspension no-sag springs

Seat cushions: HR foam 35 kg/m³ + HR foam 25 kg/m³ + cotton-wool

Back cushions: Feathers & foam flakes

Invisible legs - Fixed covers , no bedsofa

HOME SPIRIT

FRANCE



homespirit.fr



Fabrication Française



AUSTIN

Caractère & Éléance



HOME SPIRIT

FRANCE



AUSTIN

Caractère & Éléance



Fabrication Française

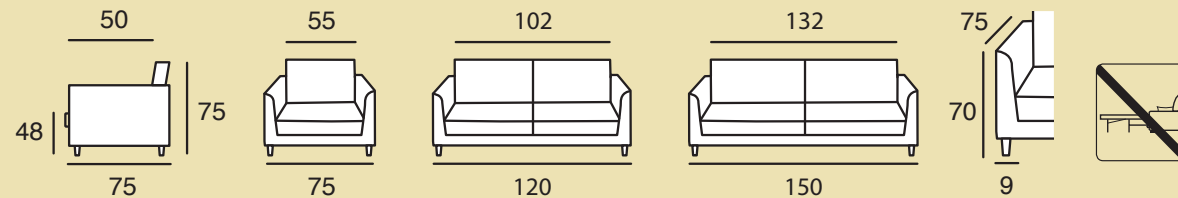

Structure : Hêtre, panneaux multiplex et panneaux de fibres. Structure enrobée de mousse polyuréthane et d'une sous-housse en foamé agrafée, suspension sangles.

Assise : Mousse HR 35 kg/m³ + HR 23 kg/m³. **Coussins de dos** : Remplissage fibres siliconées.

Pieds : Bois wengé. **Finition** : Tapissier.

Frame: Beech wood, multiplex and fiber panels. Frame wrapped in foam cover. Suspension elastic bands. **Seat cushions**: HR foam 35kg/m³ + HR foam 23 kg/m³. **Back cushions**: fibers. **Solid wooden legs** wenge color. **Fixed covers**

HOME SPIRIT

FRANCE



homespirit.fr



Fabrication Française

BALTIC

Allure & Style



HOME SPIRIT

FRANCE

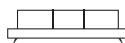

BALTIC

Allure & Style



Fabrication Française

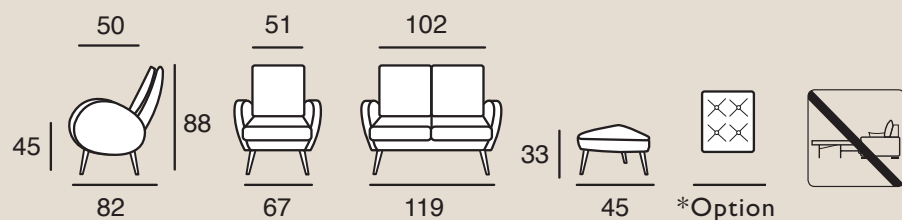

Structure : Hêtre, panneaux multiplex et panneaux de fibres. Structure enrobée de mousse polyuréthane et d'une sous-housse en foamé agrafée, suspension sangles. **Assise** : Mousse HR 35 kg/m³ + HR 23 kg/m³. **Coussins de dos*** : Remplissage fibres siliconées. **Pieds** : Bois naturel. **Finition** : Tapissier.

* Option possible : coussin de dos avec 4 capitons

Frame: Beech wood, multiplex and fiber panels. Frame wrapped in foam cover. Suspension elastic bands.

Seat cushions: HR foam 35kg/m³ + HR foam 23 kg/m³. **Back cushions***: fibers. **Solid wooden legs** natural color. **Fixed covers**.

* Option: Back cushion with 4 buttons.

HOME SPIRIT

FRANCE



homespirit.fr



Fabrication Française

BANDOL

Confort & Naturel



HOME SPIRIT

FRANCE

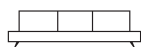

BANDOL

Confort & Naturel



Fabrication Française

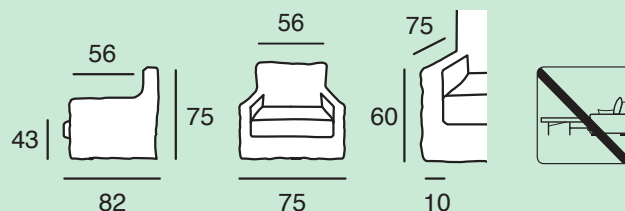

Structure : Hêtre, panneaux multiplex et panneaux de fibres. Structure enrobée de mousse polyuréthane et d'une sous-housse en foamé agrafée, suspension ressorts Nosags. **Assise** : Plumtex HR 35 kg/m³ + percale remplissage plumes. **Pieds** : Plastique. **Finition** : Déhoussable.

Frame: Beech wood, multiplex and fiber panels. Frame wrapped in foam cover. Suspension no-sag springs. **Seat cushions**: Plumtex HR foam 35 kg/m³ + layer of feathers . **Plastic legs**. **Removable covers**.

HOME SPIRIT

FRANCE



homespirit.fr



Fabrication Française

BIARRITZ & BISCARROSSE

Charme & Naturel



HOME SPIRIT

FRANCE

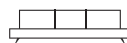

BIARRITZ & BISCARROSSE

Charme & Naturel



Fabrication Française



Biarritz

Version en multicoussins de dos
Version with loose back cushions



Biscarrosse

Version en coussins de dos placés
Version with fixed back cushions

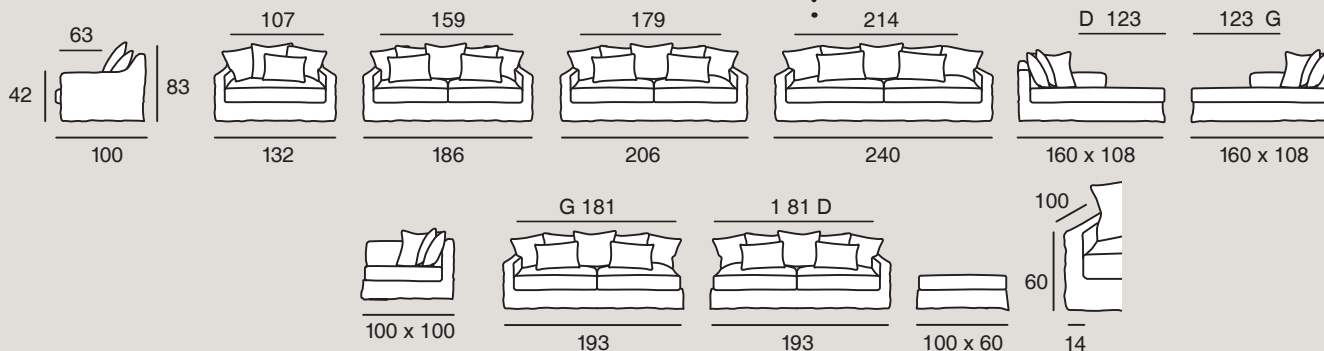

Structure : Hêtre, panneaux multiplex et panneaux de fibres. Structure enrobée de mousse polyuréthane et d'une sous-housse en foamé agrafée, suspension ressorts Nosags. **Assise :** Plumtex HR 35 kg/m³ + percale remplissage plumes. **Coussins de dos :** 60 x 60 en plumes (2 et 3 pl. = 4, 4pl. = 5). 60 x 45 en plumes (2). **Pieds :** Plastiques. **Finition :** Déhoussable.

Frame: Beech wood, multiplex and fiber panels. Frame wrapped in foam cover. Suspension no-sag springs. **Seat cushions:** Plumtex HR foam 35 kg/m³ + layer of feathers. **Back cushions:** 60x60 cm in feathers (2 & 3 seats : 4x; 3 seats: 4x; 4 seats: 5x). Cushions 60x45 in feathers (2 & 3 & 4 seats : 2x). **Plastic legs. Removable covers.**

HOME SPIRIT



homespirit.fr



Fabrication Française

BIDART

Convertible Grand Confort 14cm



HOME SPIRIT

FRANCE

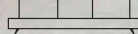

BIDART

Convertible Grand Confort 14cm



Fabrication Française

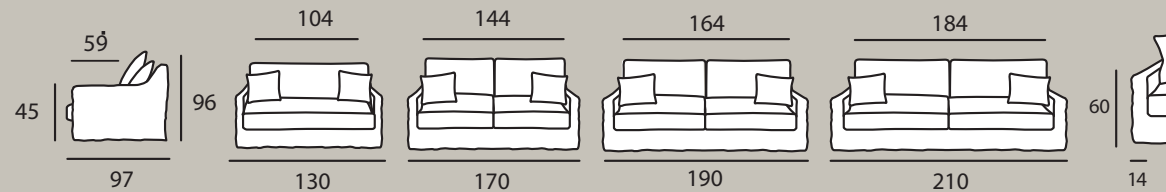

Structure : Bois massif, mécanique autoporteuse sommier grille et sangles entrecroisées en pieds.

Assise : Plumtex HR 35 kg/m³ + percale remplissage plumes. **Coussins de dos :** remplissage plumes .

Assises et dossiers restent en place à l'ouverture de la mécanique. **Finition** Déhoussable

Matelas : 14 cm. Dimensions 80 -120-140-160/ 200 cm

Frame : Solid beech wood, multiplex panels and fiber panels . Frame wrapped in foam cover and double layed with a fiber cover.

Selfsupporting bed mechanism : Grid and elastic bands. Bultex foam mattress 14 cm thick, dimensions 80/120/140/160 x 200 cm. No need to remove back and seat cushions when folding and unfolding.

Seat cushions: Plumtex HR 35 kg/m³ + layer of feathers

Back cushions: filled with feathers

HOME SPIRIT

FRANCE



homespirit.fr



Fabrication Française

CHAISES & POUF

Personnalisés & Pétillants



HOME SPIRIT

FRANCE

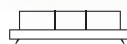

CHAISES & POUF

Personnalisés & Pétillants



Fabrication Française

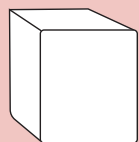

Domino
40 x 40 cm
80 x 40 cm

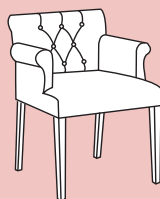

Clémentine
63 x 62 x 77 cm

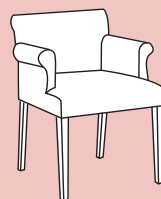

Capucine
63 x 62 x 77 cm

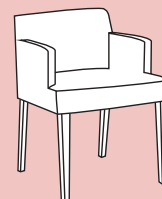

Corentin
57 x 58 x 75 cm

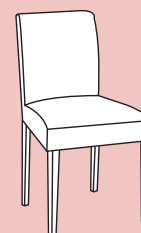

Charly
50 x 60 x 85 cm

Structure : Hêtre. Structure enrobée de mousse polyuréthane, suspension sangles.

Assise standard : Mousse HR 35 kg/m³. **Finition :** Tapissier.

*Option pied couleur Naturelle (sauf sur Charly)

*Option tissu fourni et cuir.

Frame : Beech wood. Frame wrapped in foam cover. Suspension elastic bands.

Seat cushions: HR foam 35 kg/m³. Fixed covers

*Option = Legs in natural color (Except for Charly)

*Option customers' fabric & leather

HOME SPIRIT

FRANCE



homespirit.fr



Fabrication Française

CHAMONIX

Actuel & Moelleux



HOME SPIRIT

FRANCE

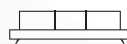

CHAMONIX

Actuel & Moelleux



Fabrication Française

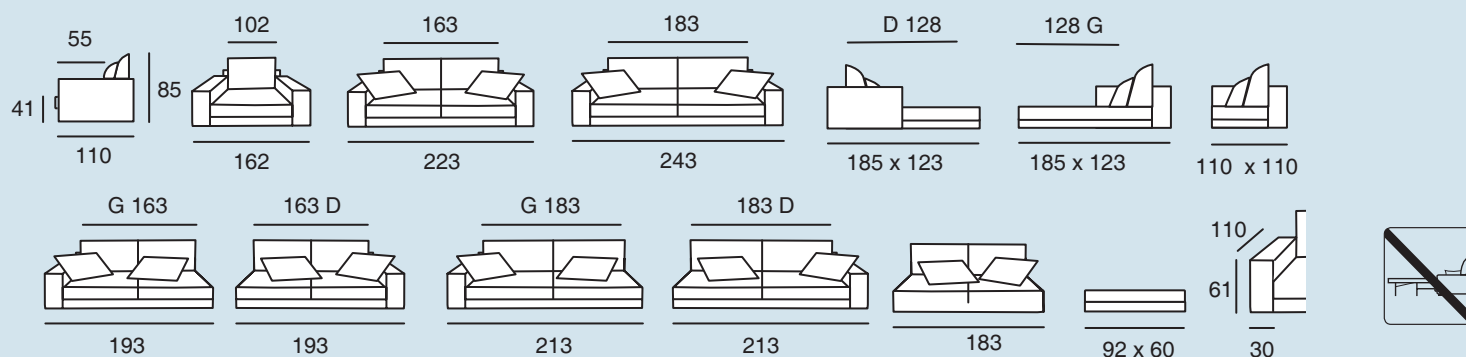

Structure : Hêtre et panneaux multiplex et panneaux de fibres. Structure enrobée de mousse polyuréthane. Manchette enrobée de ouate 650g et surmonté d'une percale en plumes, suspension ressorts Nosags. **Assise :** Plumtex HR 35 kg/m³ + percale de plumes. **Coussins de dos :** Arrière : Plumes et flocons de mousse / Avant : Remplissage plumes. **Pieds :** Bois. **Finition :** Tapissier

Frame: Beech wood, multiplex and fiber panels. Frame wrapped in foam cover. Arm covered with a 650 g cotton-wool & double layered with a percale cover with feathers. Suspension no-sag springs. **Seat cushions:** Plumtex HR foam 35 kg/m³ + layer of feathers. **Back cushions:** feathers & foam flakes / 2° range of cushions filled with feathers. **Solid wooden legs. Fixed covers.**

HOME SPIRIT

FRANCE



homespirit.fr



Fabrication Française

FARO

Élégant & Audacieux



HOME SPIRIT

FRANCE

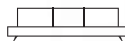

FARO

Élégant & Audacieux



Fabrication Française

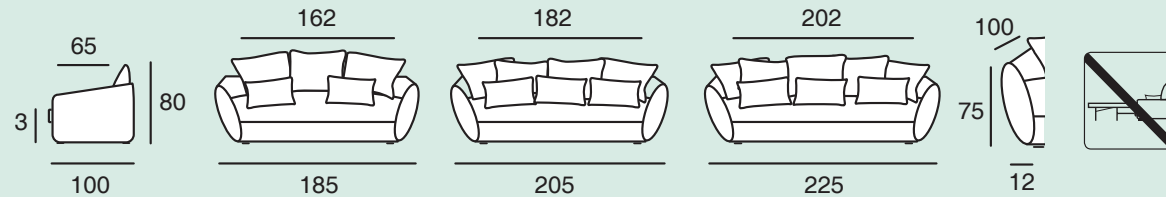

Structure : Hêtre, panneaux multiplex et panneaux de fibres. Structure enrobée de mousse polyuréthane et de ouate 650g, suspension ressorts Nosags. **Assise :** Plumtex HR 35 kg/m³ + percale remplissage plumes. **Coussins de dos :** Remplissage plumes, 3pl. = 3 de 60x60 cm + 2 de 45x60 cm, 4pl. = 4 de 60x60 cm + 3 de 45x60 cm, 5pl. = 5 de 60x60 cm + 3 de 45x60 cm. **Pieds :** Plastique. **Finition :** Tapissier.

Frame: Solid beech wood, multiplex panels and fiber panels. Frame wrapped in foam cover and double layered with a fiber cover. Suspension no-sag springs. **Seat cushions:** Plumtex HR foam 35 kg/m³ + layer of feathers. **Back cushions:** feathers (3 seats : 3c. 60x60 cm + 2c. 45x60 cm, 4 seats = 4c. 60x60 cm + 3c. 45x60 cm, 5 seats = 5c. 60x60 cm + 3c. 45x60 cm). **Plastic legs. Fixed covers.**

HOME SPIRIT

FRANCE



homespirit.fr



Fabrication Française

NOMAD

Confortable & Généreux



HOME SPIRIT

FRANCE

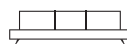

NOMAD

Confortable & Généreux



Fabrication Française

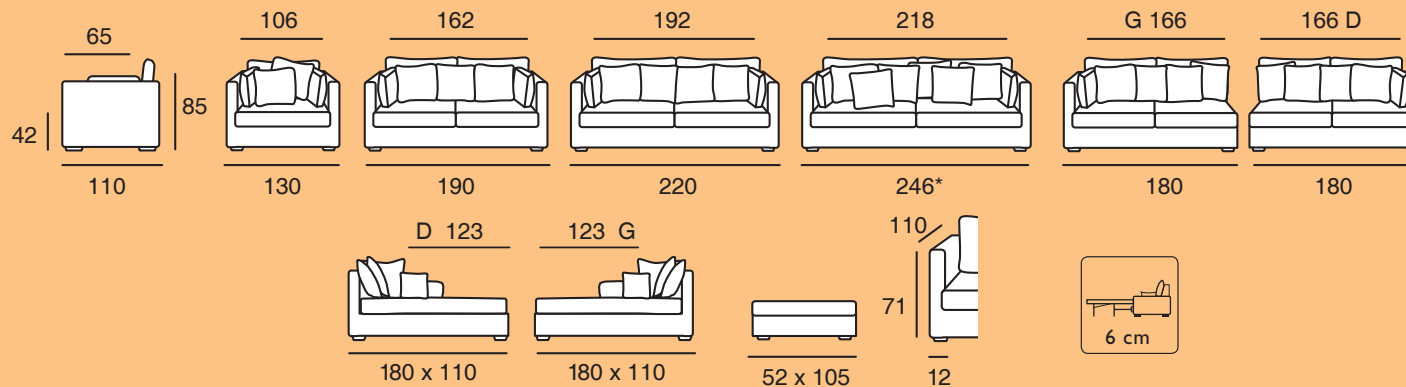

Structure : Hêtre, panneaux multiplex et panneaux de fibres. Structure enrobée de mousse polyuréthane et d'une sous-housse en foam agrafée, suspension ressorts Nosags. **Assise :** Plumtex HR 35 kg/m³ + percale remplissage plumes. **Coussins de dos :** Arrière: Plumes et flocons de mousse / Avant : Remplissage plumes. **Pieds bois.** **Finition :** Déhoussable.

* La caisse du canapé 246 cm est livrée en 2 pièces (2 structures de bâtard de 123cm avec une housse unique de 246 cm)

Frame: Beech wood, multiplex and fiber panels. Frame wrapped in foam cover. Suspension no-sag springs. **Seat cushions:** Plumtex HR foam 35 kg/m³ + layer of feathers. **Back cushions:** feathers. **Solid wooden legs.** **Removable covers.**

* Sofa 246 cm is made of 2 frames , with one unique fabric cover on the structure.

HOME SPIRIT

FRANCE



homespirit.fr



Fabrication Française



ROYAL

Tendance & Chic



HOME SPIRIT

FRANCE

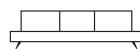

ROYAL

Tendance & Chic



Fabrication Française

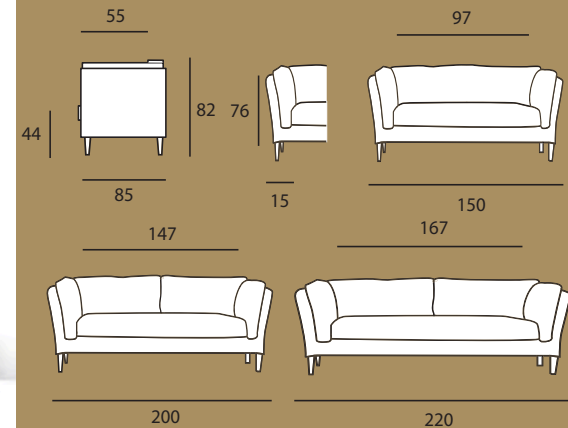

Option : capitons sur les coussins / with buttons

Structure : Hêtre, panneaux multiplex et panneaux de fibres. Structure enrobée de mousse polyuréthane et d'une sous-housse en foamé agrafée. Suspension ressorts Nosags. **Assise:** mousse HR 35 kg/m³+ percale remplissage plumes. **Coussins de dos :** Plumes + Flocons de mousse. **Finition :** Déhoussable, non convertible
Pieds: Bois 18 cm

*Frame : Solid wood, multiplex and fiber panels. Frame wrapped in foam cover and double layered with a fiber cover.
Suspension no-sag springs
Seat cushions: Plumtex HR 35 kg/m³ + layer of feathers .
Back cushions: Feathers & Foam flakes . Deco cushions filled with Feathers & Foam flakes
Solid wooden legs 18 cm high. Removable covers No bedsofa*

HOME SPIRIT



homespirit.fr



Fabrication Française



VANG

Contemporain & Épuré



HOME SPIRIT

FRANCE

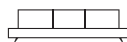

VANG

Contemporain & Épuré



Fabrication Française

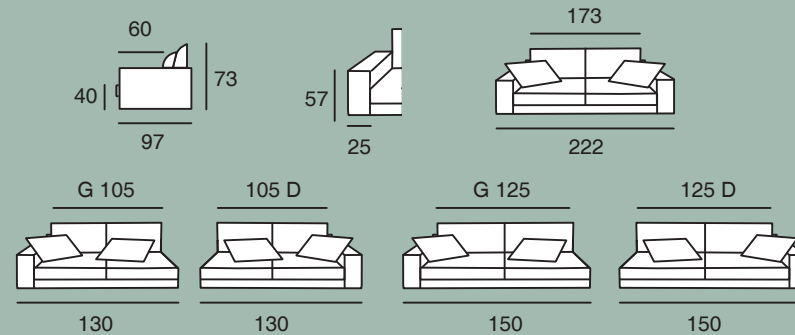

Structure : Hêtre, panneaux multiplex et panneaux de fibres. Structure enrobée de mousse polyuréthane et d'une sous-housse en foamé agrafée, suspension ressorts Nosags. **Assise standard**

: Mousse HR 35 kg/m³ + HR 25 kg/m³.

Coussins de dos : Fibres. **Coussins de déco :** Remplissage plumes. **Pieds :** Bois. **Finition :** Tapissier.

Frame: Beech wood, multiplex and fiber panels. Frame wrapped in polyurethane foam and with a white foam cover. Suspension elastic bands. **Seat cushions:** HR foam 35kg/m³ + HR foam 23kg/m³. **Back cushions:** Fibers. **Deco cushions:** Filled with feathers. **Legs wood. Fixed covers.**

HOMÉ SPIRIT

FRANCE



homespirit.fr



Fabrication Française

SOFA'CHIC

Le créateur de votre canapé



HOME SPIRIT

FRANCE

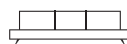

SOFA'CHIC

Le créateur de votre canapé



Fabrication Française

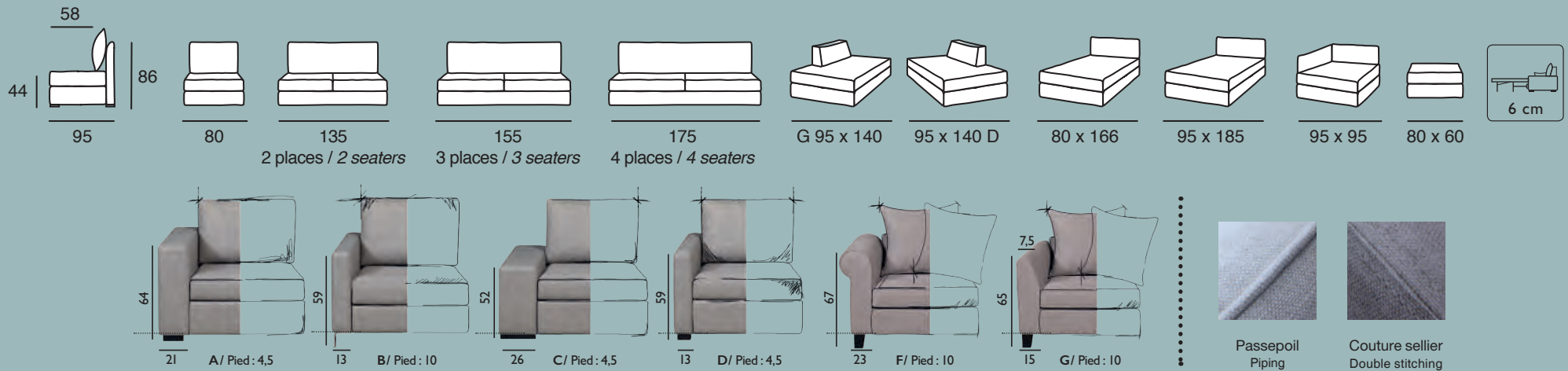

Structure : bois massif, panneaux de fibres et panneaux de particules, structure enrobée de mousse polyuréthane et d'une sous-housse en foamé blanc agrafée. Suspension Nosags. **Assise :** Mousse HR 35 kg/m³ + HR 23 kg/m³. **Coussins de dos :** Remplissage fibres siliconées / en multicoussins (60x60 cm) : chauffeuse simple et longue = 2, chauffeuse d'angle = 3, 2 et 3 pl. = 4, 4 p. = 5. **Finition :** Tapissier, cuir possible.

* Option : Assises HR 35 kg/m³ + percale remplissage plumes + coussins de dos en plumes.

* Option convertible : 6 cm.

Frame: Solid beech wood, multiplex and fiber panels. Frame wrapped in foam cover. Suspension no-sag springs. **Seat cushions:** HR foam 35 kg/m³ + HR foam 23 kg/m³. **Back cushions:** fibers. Multi cushions-Pillows (60x60 cm) Single Element and Long Chair = 2 cushions, Corner = 3 cushions, 2 and 3 seats = 4 cushions, 4 seats = 5 cushions. **Fixed covers.** Available in leather.

* Option: Plumtex seat cushions HR 35 kg/m³ + layer of feathers & back cushions filled with feathers.

* Option with bed mechanism: 6 cm thick mattress

HOME SPIRIT

FRANCE



homespirit.fr



Fabrication Française

SOFA'CHIC

En version convertible grand confort 14cm

Créez votre véritable lit

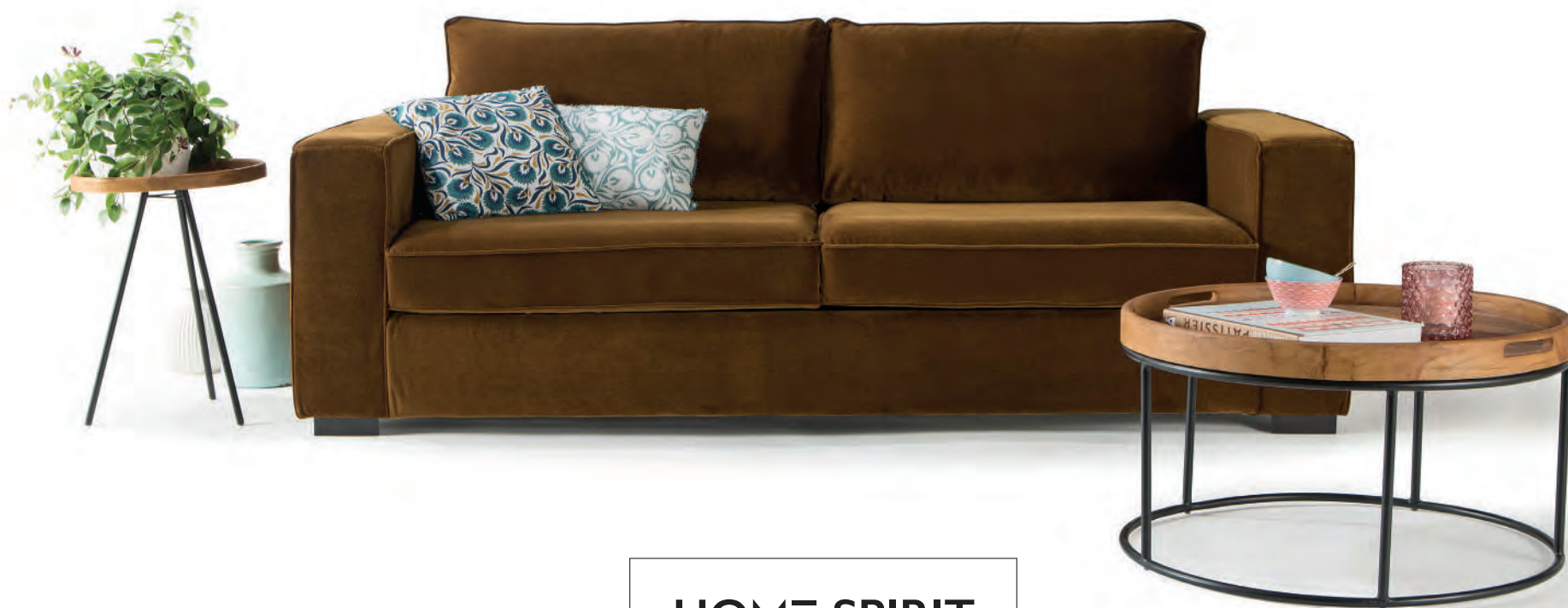

HOME SPIRIT

FRANCE

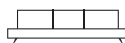

SOFA'CHIC

En version convertible grand confort 14cm

Créez votre véritable lit



Fabrication Française

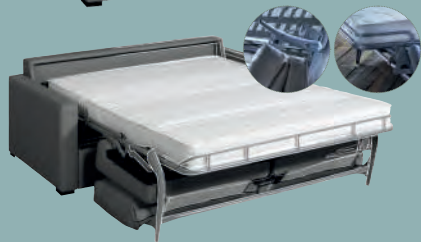
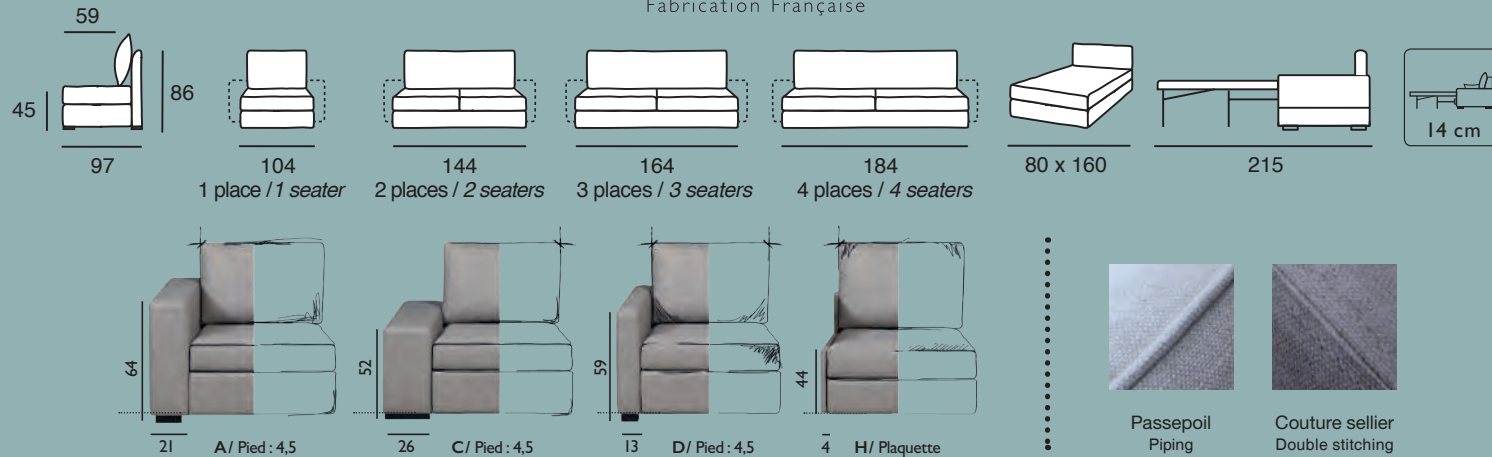

Structure : Bois massif, mécanique autoporteuse sommier grille et sangles entrecroisées en pieds. **Assise :** Mousse HR 35 kg/m³ + HR 23 kg/m³. **Coussin de dos :** remplissage fibres siliconées. Assises et dossiers restent en place à l'ouverture de la mécanique. **Finition :** Tapissier, cuir possible. **Matelas :** 14 cm, dimensions 80/120/140/160 x 200 cm.

Frame: Solid beech wood, multiplex and fiber panels. Frame wrapped in foam cover. Self supporting bed mechanism, grid and bands. HR foam **mattress** 14 cm thick, dimensions 80/120/140/160 x 200 cm. No need to remove back and seat cushions when folding and unfolding. **Seat cushions:** HR foam 35 kg/m³ + HR foam 23 kg/m³. **Back cushions:** fibers. **Fixed covers** . Possible in leather.

HOME SPIRIT



homespirit.fr