

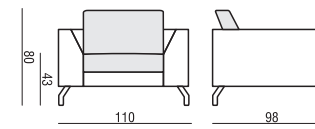

ARMCHAIR

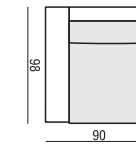

ARMCHAIR LEFT (or RIGHT)



ARMCHAIR without ARMRESTS

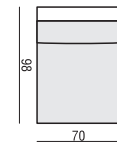

ARMCHAIR WIDE

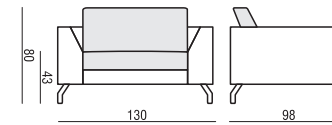

ARMCHAIR WIDE LEFT (or RIGHT)

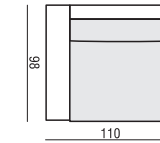

ARMCHAIR WIDE without ARMREST

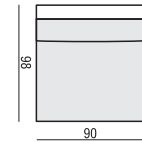

2 SEATER

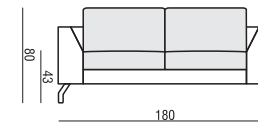

2 SEATER LEFT (or RIGHT)

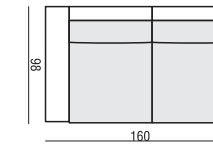

2 SEATER without ARMRESTS

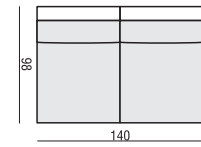

3 SEATER

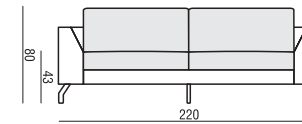

3 SEATER LEFT (or RIGHT)

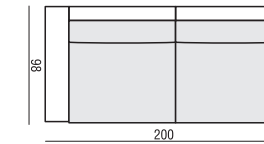

3 SEATER without ARMRESTS

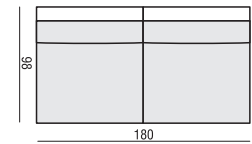

3XL SEATER

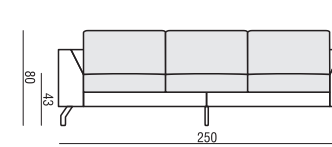

3XL SEATER LEFT (or RIGHT)
available in two parts

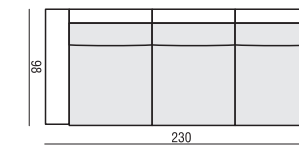

3XL SEATER without ARMRESTS
available in two parts

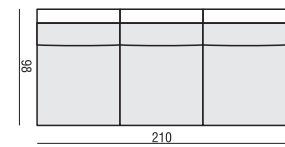

3XL SEATER two parts

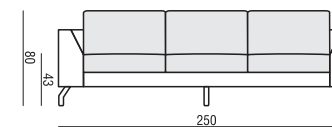

CORNER 90°

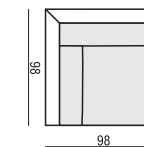

CHAISELONGUE LONG LEFT (or RIGHT)

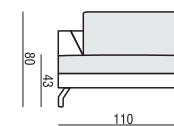

CHAISELONGUE LEFT (or RIGHT)

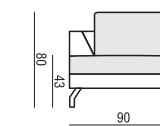

BENCH LEFT (or RIGHT)

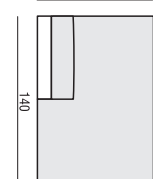
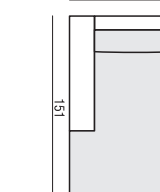
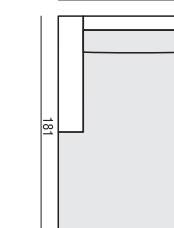
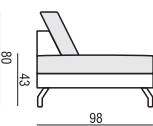

FOOTSTOOL 90x70

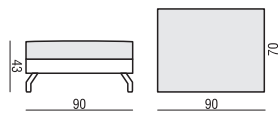

FOOTSTOOL 100x90

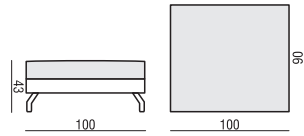

SET 1 LEFT (or RIGHT) CHAISELONGUE LEFT (or RIGHT) + 2 SEATER RIGHT (or LEFT)

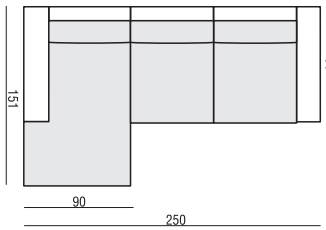

SET 2 LEFT (or RIGHT) CHAISELONGUE LONG LEFT (or RIGHT) + 3 SEATER RIGHT (or LEFT)

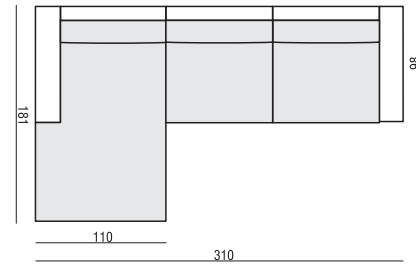

SET 10 LEFT (or RIGHT) BENCH LEFT (or RIGHT) + CORNER 90° + 3 SEATER RIGHT (or LEFT)

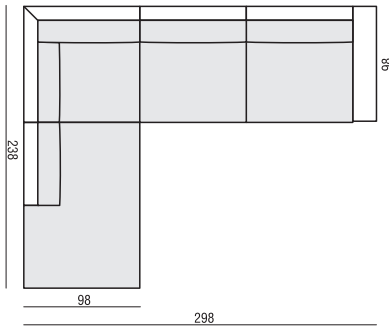

SET 11 LEFT (or RIGHT) BENCH LEFT (or RIGHT) + CORNER 90° + 2 SEATER RIGHT (or LEFT)

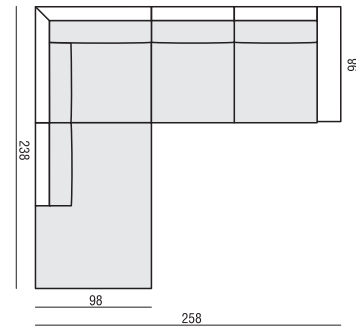

UPHOLSTERY

FABRIC or LEATHER: FC - fix cover

FEET

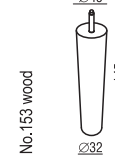
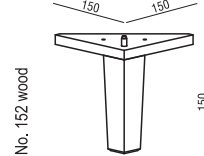
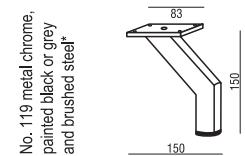
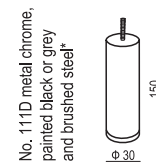
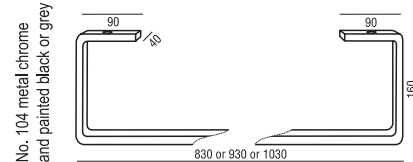
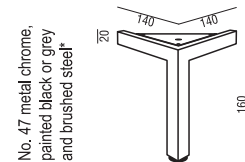

*please check a cost of brushed steel finish with a sale representative

SITS reserves the right to change construction of products and components used due to improving durability of product and customer satisfaction without any further notice. Explicit ±2 cm tolerance of all elements sizes.

CLASSIC COMFORT

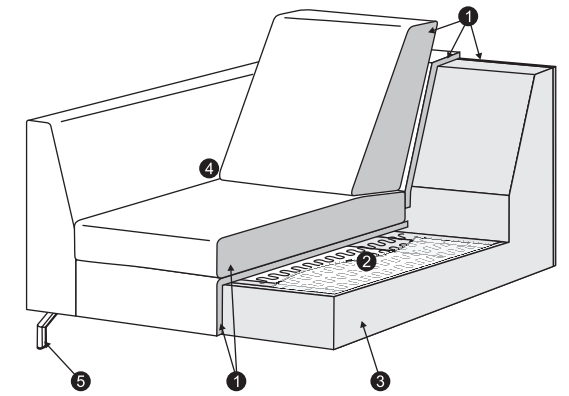

1. polyurethane foam/high resilient polyurethane foam
2. springs
3. FSC® certified solid wood and wood based elements
4. fabric or leather
5. FSC® certified solid wood or metal legs

STANDARD COMFORT

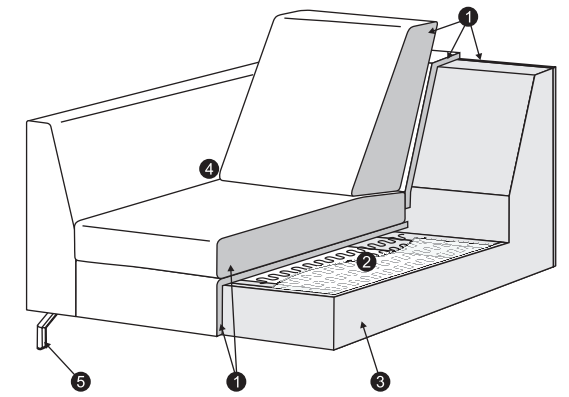

1. polyurethane foam/high resilient polyurethane foam
2. springs
3. FSC® certified solid wood and wood based elements
4. fabric or leather
5. FSC® certified solid wood or metal legs

LUX COMFORT

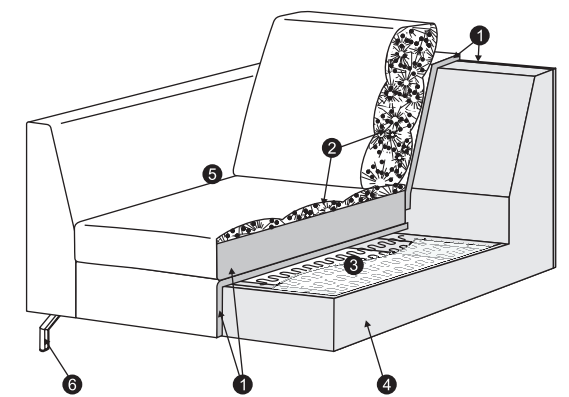

1. polyurethane foam/high resilient polyurethane foam
2. cushion chamber with mix of feather and silicone balls
3. springs
4. FSC® certified solid wood and wood based elements
5. fabric or leather
6. FSC® certified solid wood or metal legs

PREMIUM COMFORT

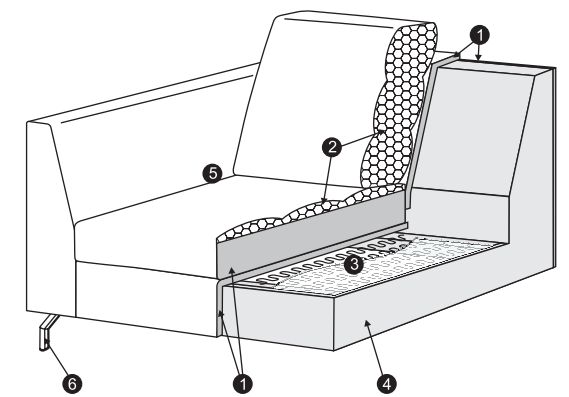

1. polyurethane foam/high resilient polyurethane foam
2. silicone balls
3. springs
4. FSC® certified solid wood and wood based elements
5. fabric or leather
6. FSC® certified solid wood or metal legs